

**BREAK
THROUGH.
BUILD
BEYOND.**

Red
R200



HKM

Grey
G280

Red R50



STANDARD EQUIPMENTS

-  High Pressure Accumulator
-  High Efficiency & Performance
-  Easy Sparepart Replacement & Service

OPTIONAL EQUIPMENTS

-  Underwater Equipment
-  Reinforced Housing
-  Quick Coupler
-  Noise Absorption

NON-STOP PERFORMANCE

HKM Red 50 is engineered to maximize your efficiency on your trench, asphalt breaking and demolition works within cities. Compatible with mini excavators & back hoe loaders from 5 to 9 tons.

With its full hydraulic working principle and high pressure accumulator, HKM Red 50 avoids power loss caused by lack of gas pressure between jobs. Red 50's 40 bar high pressure accumulator saves you time & fuel with its high demolition power.

Fully foldable design of R50 housing minimizes the stress to carrier boom during travel. Optimum piston stroke length protects itself and carrier. As a result it is unrivaled in spare part service time.

R50 will be there to rely on for various demolition operations in cities with its non-stop demolition power.

TECHNICAL SPECIFICATIONS

| HKM RED 50 |

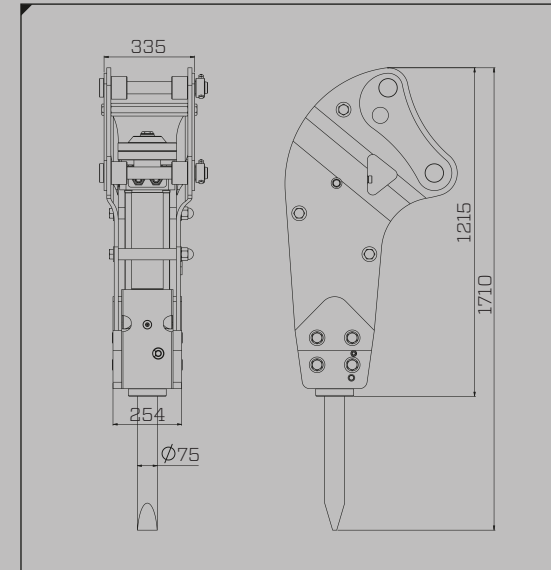

| TECHNICAL DATA |

Operational Weight (kg)	370
Carrier Weight (ton)	3-9
Tool Diameter (mm)	75
Working Pressure (bar)	110-130
Oil Flow (l/min)	50-100
Impact Rate (bpm)	500-900

Save time & fuel
with R 50's high
demolition power



Red LINE



TECHNICAL SPECIFICATIONS	R50	R100	R150	R200	R250	R260	R300	R350
Operating Weight (kg)	370	960	1650	1842	2250	2510	2960	3750
Tool Diameter (mm)	75	100	120	130	140	150	160	175
Input Power (kw)	15,0	18,4	30,3	32,5	45,5	47,8	49,0	52,5
Operating Pressure (bar)	110-130	120-140	120-140	120-140	130-150	130-150	130-150	130-150
Oil Flow (l/min)	50-100	70-100	100-180	120-180	160-230	170-240	170-250	210-240
Impact Rate (bpm)	500-900	350-650	350-600	400-550	400-550	400-550	300-450	300-400
Carrier Weight (ton)	3-9	10-16	18-26	22-29	25-34	29-40	33-45	40-55

Red LINE

SUPERIORITIES

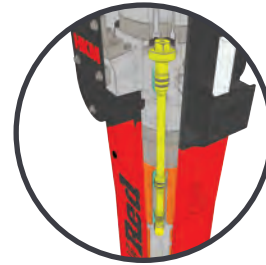

Nut free tie rod design

Optimum piston stroke length, minimum excess energy

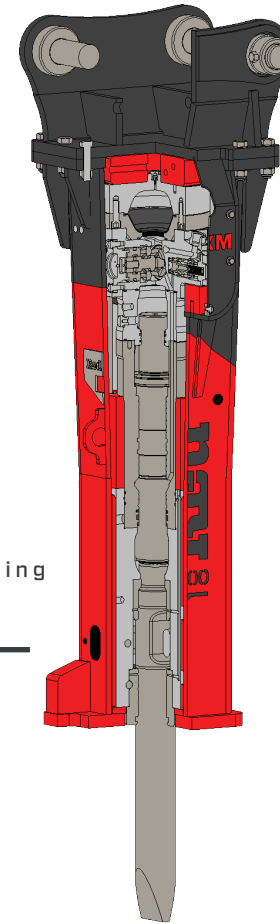

Automatic lubrication with hydraulic control *



Reinforced housing against extreme conditions *



Maximum sound and vibration dampening with increased wear plates



* Optional Equipments

Red Line / Hydraulic

Red

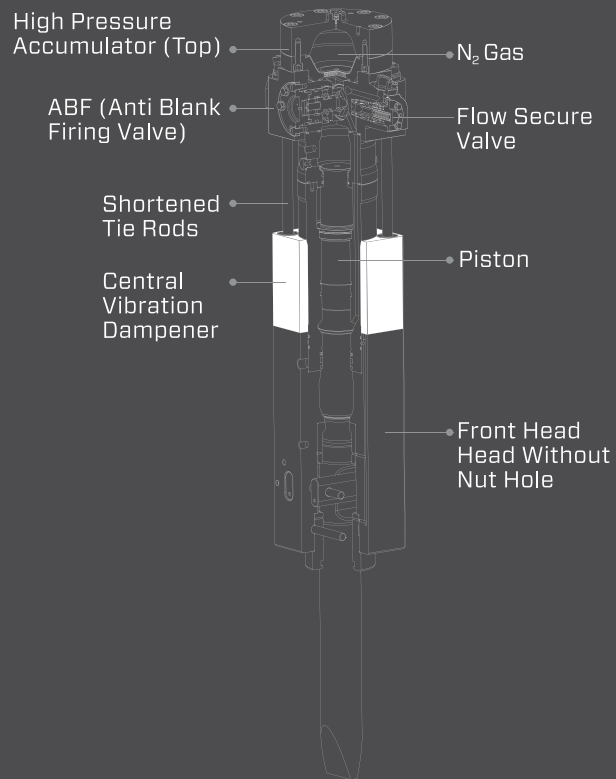

Grey Line / Hybrid

Grey

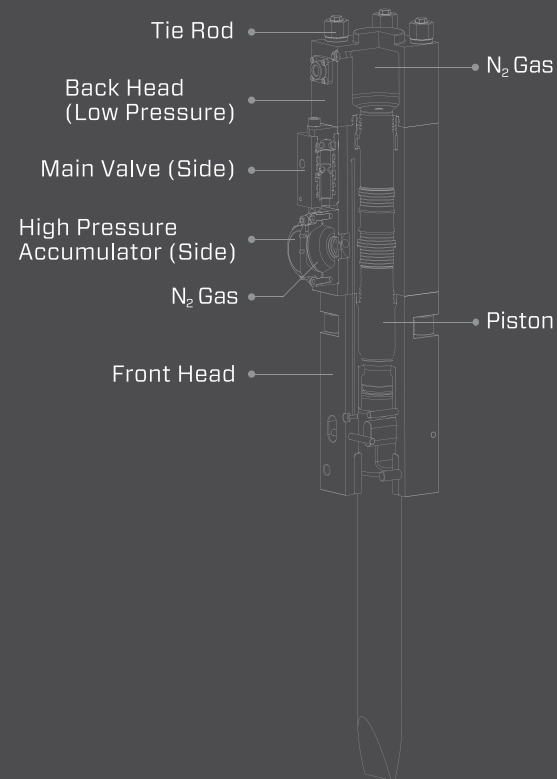

BREAK THROUGH. BUILD BEYOND. HKM

Showroom

Dudullu OSB Mahallesi, Imes Sanayi Sitesi C306 Sk. No:2, 34775 Umraniye, Istanbul/Turkiye

+90 216 499 4585

sales@hkm.com.tr

www.hkm.com.tr

@hkmbreakers in @hkmbreakers

HKM